

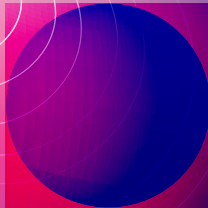

Learn more:
<https://go.qct.io/telco/omnipod-enterprise-5g/>

QCT OMNIPOD ENTERPRISE 5G

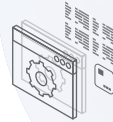
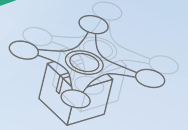
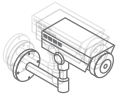

intel®

QCT OmniPOD Enterprise 5G Overview

QCT OmniPOD Enterprise 5G is an ideal solution for businesses looking to transition to standalone (SA) 5G core and RAN networks, making possible a whole new range of 5G services from enhanced mobile broadband (eMBB), massive machine-type communication (mMTC), to ultra-reliable low latency communication (URLLC).

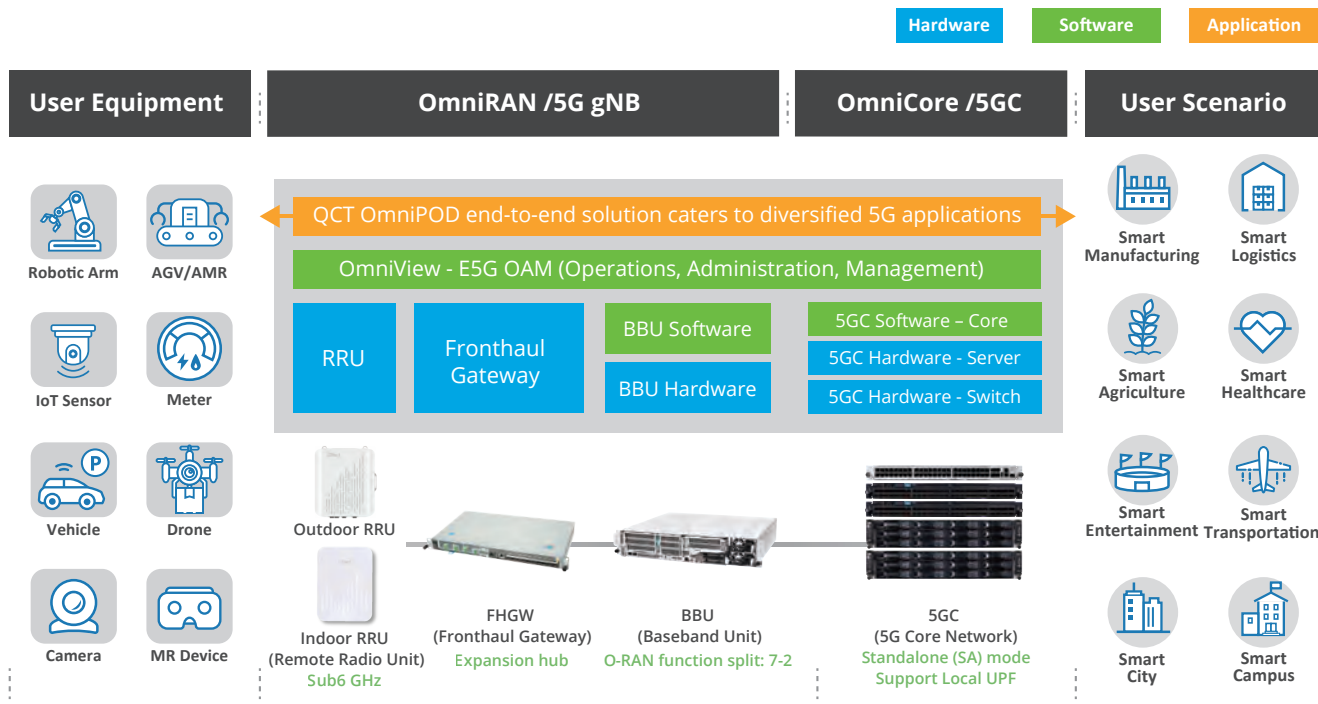

Powered by Intel® Technology.

Learn more: <https://go.qct.io/telco/omnipod-enterprise-5g/>

QCT OmniPOD Enterprise 5G Deployment

QCT OmniPOD supports various scales from single-site to multi-site Enterprise 5G deployments, depending on different scenarios. QCT OmniPOD includes Control and User Plane Separation (CUPS) design in the network function architecture. It allows user data be computed in edge sites, decreasing data transmission latency and increasing the efficiency of operation and management in local sites.

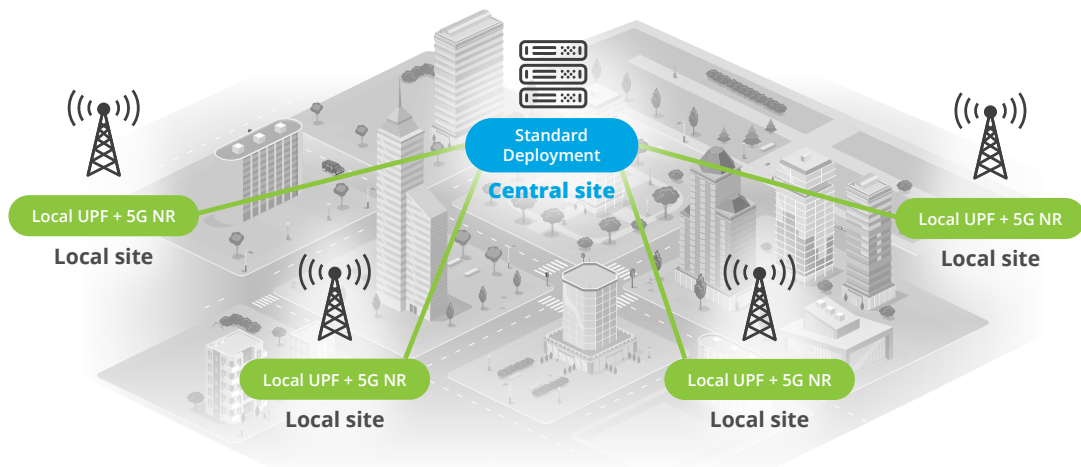

Scalable deployment

Support local UPF (based on CUPS design)

Single-site and multi-site deployment

Operation and management for central & local site

QCT OmniCore Overview

QCT OmniCore is a cloud-native, virtualized 5G core network solution built on commodity hardware that allows for the optimization of network functions and the realization of dynamic 5G applications and services (e.g., eMBB, mMTC, URLLC) for diverse vertical industry requirements.

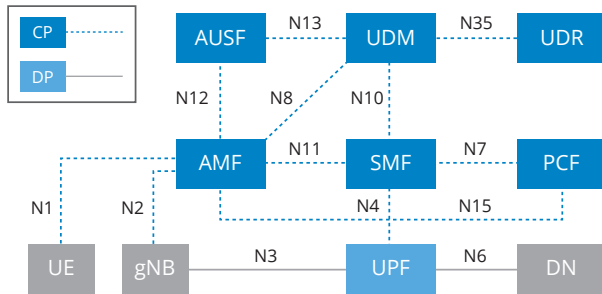

- ✓ 3GPP Release 15 compliant
- ✓ Standalone (SA) mode
- ✓ High Availability (HA) design
- ✓ Control & User Plane Separation (CUPS)
- ✓ Support Local UPF in multi-site deployments
- ✓ Up to 160 Gbps DL/UL combined
- ✓ Up to 10,240 simultaneously attached UEs

QCT OmniCore Hardware



Powered by Intel® Xeon® Scalable Processors



5G Core Server



Data Switch



Management Switch



Local UPF Server

5G Core Architecture

5GC Hardware Model

- 5GC Server x2
- Data Switch x2
- Management Switch x1
- (Optional) Local UPF Server

Network Function

CP: AMF, SMF, UDM, UDR, AUSF, PCF/ DP: UPF

Reference Interface

N1, N2, N3, N4, N6, N7, N8, N10, N11, N12, N13, N15, N35

5G Core Server Specifications

Environment

- Operating temperature: 5°C ~ 40°C
- Operating relative humidity: 20% ~ 85%

Power Supply

110/220V AC

Power Consumption

< 1200W (Active & Standby server)

Dimensions & Weight

(W) 440 x (H) 87.5 x (D) 780 mm ; < 35kg

Local UPF Server Specifications

Environment

- Operating temperature: 5°C ~ 40°C
- Operating relative humidity: 5% ~ 85%

Power Consumption

<700W

Dimensions & Weight

(W) 447.8 x (H) 86.3 x (D) 420 mm ; < 25kg

QCT OmniCore HA Mechanism

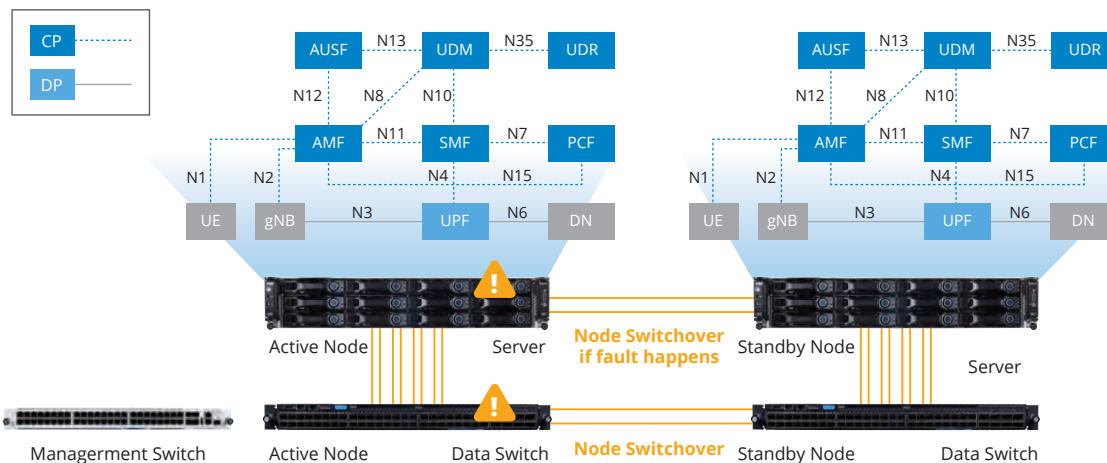

Continuous service availability for a long time.



Automatic node switchover when fault happens.



Immediate system backup and failsafe PDU session.

QCT OmniRAN Overview



Disaggregated platform

BBU software on top of x86 Edge Servers.



Various deployment options

Both indoor and outdoor options are available to meet various deployment scenarios in customer fields.



Standard compatibility

3GPP standard compliant to interwork with different 5G terminals.



Configurable ratio for uplink and downlink time slots

Configurable slot format to accommodate varying uplink and downlink data rates for different use cases.



Expandable radio network for each cell

Depending on field coverage requirements, each cell can support multiple remote radio units (RRUs).



Standard time synchronization protocol

The Fronthaul Gateway receives GPS signal and serves as the Grand Master of PTP/IEEE-1588 to synchronize time with the Remote Radio Unit and the Baseband Unit.

QCT OmniRAN in US Market - Citizens Broadband Radio Service (CBRS)

Targeting the US market, QCT OmniRAN fulfills US requirements for the Citizens Broadband Radio Service (CBRS). CBRS comprises 150 MHz (n48, 3550-3700MHz) shared spectrum for US public use with 3-tier usage prioritizing. QCT supports Priority Access License (PAL) and General Authorized Access (GAA) user requirements.

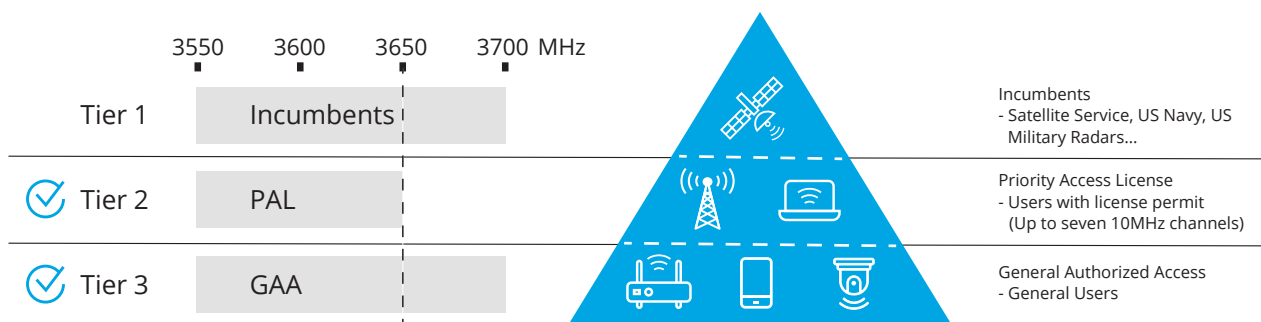

*CBRS 3 Tiers' Users:

Federal Communications Commission (FCC) requires that GAA users cannot interfere with PAL or incumbent users, and PAL users cannot interfere with incumbent users.

QCT OmniRAN CBRS is controlled by a Spectrum Access System (SAS), the frequency coordination system across the 3 tiers. SAS is operated by third party providers authorized by Federal Communications Commission (FCC).

Citizens Broadband Radio Service Devices (CBSDs), or the RRUs, will register with a SAS for CBRS services and subsequently request its spectrum granted through Domain-Proxy as the proxy role.

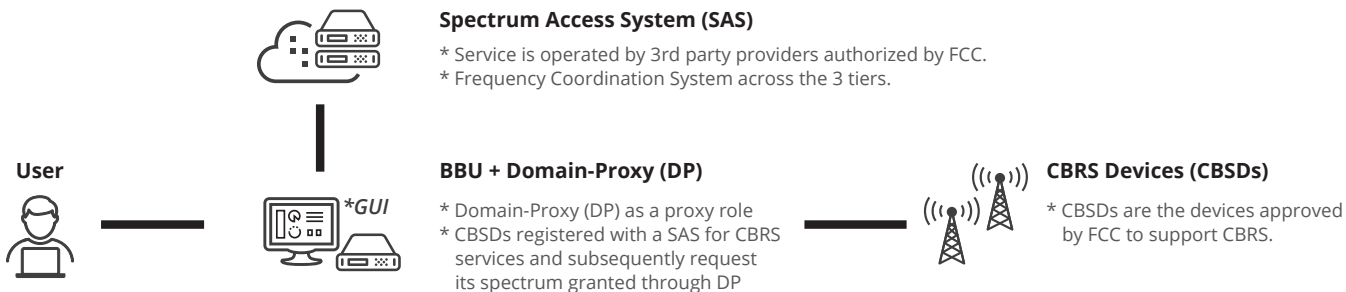

FCC Both QCT Indoor CBSD & Outdoor CBSD have been approved by Federal Communications Commission (FCC).



IronRAN-RUX PI GenA (Indoor RRU)
 CBSD Category: A
 FCCID: HFS-IRONRAN-RU5PI



IronRAN-RUX MO GenA (Outdoor RRU)
 CBSD Category: B
 FCCID: HFS-IRONRAN-RU4MO

QCT OmniRAN Product Specifications

OmniRAN-E5GBBU
Front View



OmniRAN-E5GBBU
Rear View



Powered by
Intel® Xeon® Scalable
Processors

IronRAN-FG GenA
Front View



IronRAN-FG GenA
Rear View



BBU Product Specifications

Model Name	OmniRAN-E5GBBU	Frame Structure	Pattern1: DDSUDDSUU Pattern2: DDSUU Pattern3: DSUUU Pattern4: DDSUU DDDD (TDD-Sync for Japan) Pattern5: DDSUU DSUU (Semi-Sync for Japan)
Standard	3GPP R15 SA	Power Consumption	<800W
Modulation	Downlink: QPSK, 16QAM, 64QAM, 256QAM Uplink: QPSK, 16QAM, 64QAM	Power Supply	110/ 220V AC
Active User/ Connected User	128 active UE/ 384 connected UE	Dimension and Weight	(W)447.8 x (H)86.3 x (D)420 mm, 25kg
Cell bandwidth	10/20/40/50/60/80/90/100 MHz per cell (Support multiple bands depending on 3GPP-defined specifications)	Environment	Operating temperature: -5°C ~ 55°C Operating relative humidity: 15% ~ 85%

FHGW Product Specifications

Model Name	IronRAN-FG GenA	Power Consumption	<70W
RRU Support	Support RRU up to 100 MHz; Multiple RRUs supported	Dimension and Weight	(W)446 x (H)44.5 x (D)250 mm, 4.3kg
Time Synchronization	Embedded GPS module (IEEE 1588v2 grand master)	Power for RRU	+54V DC, 80W
Ingress Protection	IP20	Environment	Operating temperature: -5°C ~ 45°C Operating relative humidity: 5% ~ 95%
Power Supply	110/220V AC		

Indoor RRU Product Specifications

Model Name	IronRAN-RUx PI GenA	Ingress Protection	IP30 for indoor
Band	n48, 3550 MHz – 3700 MHz n78, 3300 MHz – 3800 MHz n79, 4600 MHz – 4900 MHz	Power Supply	54V DC (by FHGW) or 110/220V AC (by local with adapter)
Bandwidth	Support up to 100 MHz	Power Consumption	60W
MIMO	4T4R	Dimension and Weight	(W)204.7 x (H)259.6 x (D)52.5 mm without mounting kit (W)204.7 x (H)259.6 x (D)72.5 mm with mounting kit 1.34kg
Maximum Output Power	4x 250mW	Environment	Operating temperature: -5°C ~ 45°C Operating relative humidity: 5% ~ 95%
Synchronization	IEEE 1588v2	Noise	Under normal temperature (25°C) < 40 dBA
Placement	Wall mount & ceiling mount		
Function Split	O-RAN option 7-2		

IronRAN-RUx PI GenA is the first RRU product to obtain both Taiwan certification and Japan TELEC certification for n79.

Outdoor RRU Product Specifications

Model Name	IronRAN-RUx MO GenA	Function Split	O-RAN option 7-2
Band	n48, 3550 MHz – 3700 MHz n78, 3300 MHz – 3800 MHz n79, 4600 MHz – 4900 MHz	Ingress Protection	IP65
Bandwidth	Support up to 100 MHz	Power Supply	110/220V AC
MIMO	4T4R	Power Consumption	180W (4T4R)
Maximum Output Power	4x 5W	Fan	Fanless design
Synchronization	IEEE 1588v2	Dimension and Weight	(W)355 x (H)418.5 x (D)165 mm, 15kg
Placement	Wall mount & pole mount	Environment	Operating temperature: -40°C ~ 55°C (best case) Operating relative humidity: 5% ~ 95%

QCT OmniView Overview

QCT OmniView is a network management system for monitoring QCT OmniPOD hardware and software.

It serves as a pair of eyes overseeing the overall network system, providing 8 major functions with a user-friendly, web-based, and visual management.



QCT OmniView Dashboard

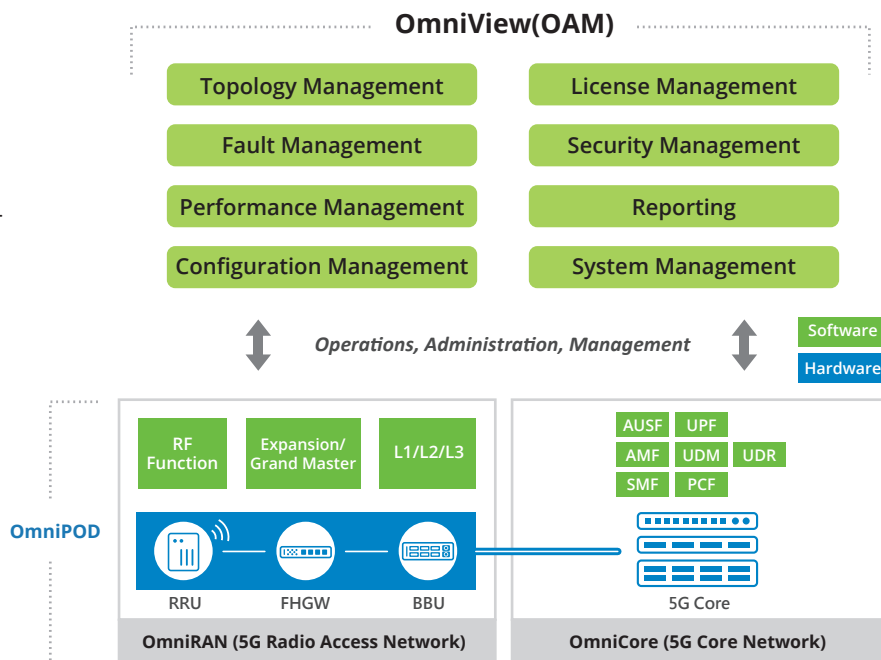

QCT OmniView Architecture

QCT OmniView Features

Visualized Management

Key system indicators are visualized in a graphic dashboard for easy management.

Single Pane of Glass Display

All network data is displayed in a unified view.

SIM Provisioning & Management

Activating, deactivating, managing SIM card remotely.

Real-time Fault Notification

Immediately sends out email alerts upon the detection of a fault.

3GPP-based KPI Measurement

Performance is measured by 3GPP standards.

IP Whitelist Control

Network access is only granted to IP addresses that users authorized.

QCT OmniView Functions



Topology Management

Display the physical and logical views of the network structure, networking relation, and operating status of QCT OmniPOD.



Fault Management

Manage and monitor all alarms that are generated by NFs and hardware of OmniPOD.



Performance Management

Display and monitor the key performance indicators that are generated by OmniPOD.



Configuration Management

Execute SIM import and UE provisioning of OmniCore, and configure the key parameters of OmniRAN.



License Management

Manage OmniPOD license.



Security Management

Manage users and user groups as well as to record operation logs.



Reporting

Allows users to manage and export all reports that are generated by the network system.



System Management

Display basic system information and set up the overall system such as NTP server & mail server settings.

QCT Enterprise 5G for Digital Transformation

With a comprehensive portfolio and solution deployment know-how, QCT is taking the lead in helping enterprises capture the value of 5G private networks, unlocking a whole world of use cases for businesses to stay ahead of the game in this age of rapid digital transformation.

Smart Manufacturing



Smart Theater



Smart Agriculture



Smart Healthcare



QCT's Successful Smart Manufacturing Use Cases

Realize smart factories with QCT's enterprise 5G OmniPOD solution.

Taking advantage of the high bandwidth and low latency of 5G, QCT's Enterprise 5G solutions ensure the real-time transmission of large-scale data to meet varying customer demands.

- ✓ IoT
- ✓ Security
- ✓ Automation
- ✓ Quality Control

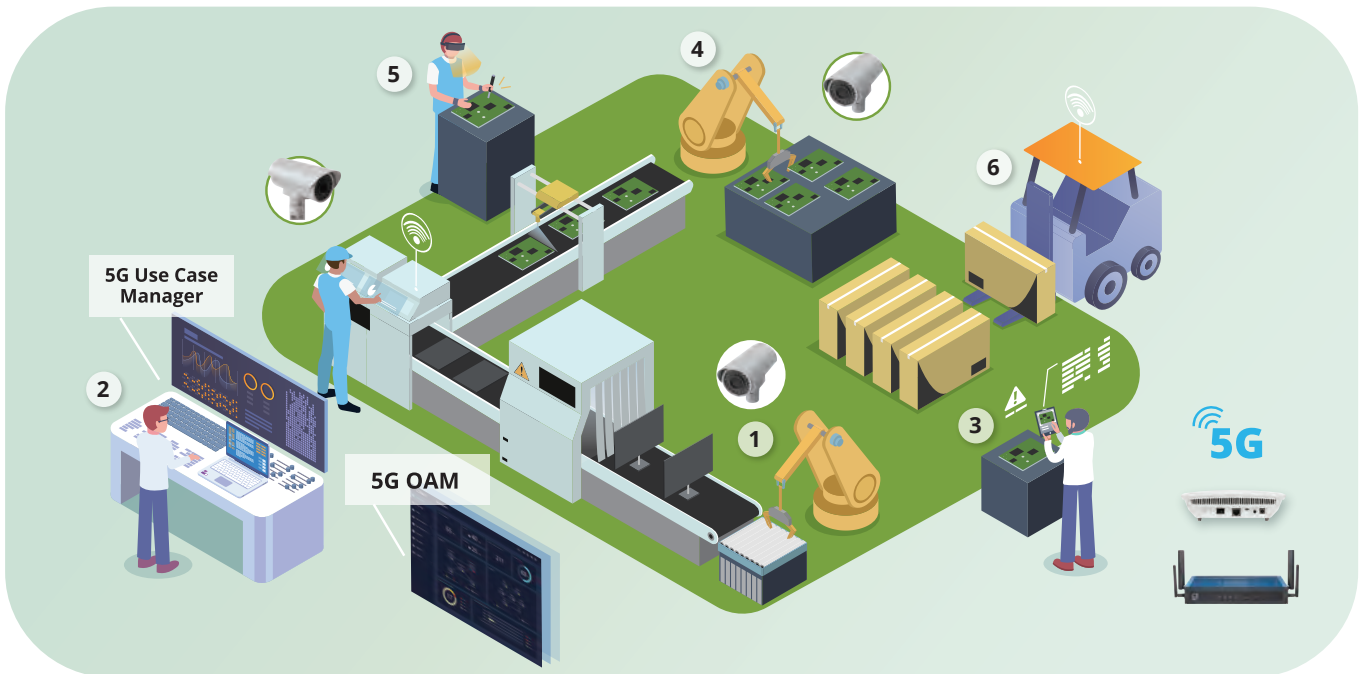

1 Safety AI

To ensure workplace safety and security, image recognition technology is used for real-time monitoring to detect noncompliance of safety regulations, generate automated alerts, and halt dangerous machinery when trespassing occurs; a safety AI dashboard is used for easy management.

2 AR Information Visualization

To easily monitor the production line status at a glance, AR technology is used to display production equipment operating and product assembly statuses in real time.

3 AR Identification

To lower the specialist background threshold required, image recognition and AR technology are used to display product model information and installation instructions.

4 Image Archiving

To provide control for future maintenance needs, high-resolution images of all products are recorded by industrial-grade cameras.

5 AR Repair

To improve maintenance efficiency, image recognition and AR technology are used to display fault and repair instructions.

6 AGV Transportation

Through the deployment of 5G signals throughout the factory, AGVs can be controlled by a central management system for parts and equipment transportation.

About QCT

Quanta Cloud Technology (QCT) is a global data center solution provider. We combine the efficiency of hyperscale hardware with infrastructure software from a diversity of industry leaders to solve next-generation data center design and operation challenges. QCT serves cloud service providers, telecoms and enterprises running public, hybrid and private clouds.

Product lines include hyper-converged and software-defined data center solutions as well as servers, storage, switches, integrated racks with a diverse ecosystem of hardware component and software partners. QCT designs, manufactures, integrates and services cutting edge offerings via its own global network. The parent company of QCT is Quanta Computer, Inc., a Fortune Global 500 corporation.

Learn more about
QCT Telco Solutions



Learn more about
QCT OmniPOD



QCT Authorized Partner



© 2023 Quanta Computer Inc. All rights reserved. Specifications and figures are subject to change without prior notice.

All other brand trademarks, logos, and names are the property of their respective owners. All campaign statements and product images contained herein are copyrighted and may not be reprinted and/or reproduced, in whole or in part without the written consent of Quanta Computer Inc.

QCT, the QCT logo, Rackgo, Quanta, and the Quanta logo are trademarks or registered trademarks of Quanta Computer Inc. QCT shall not be liable for technical or editorial errors or omissions contained herein.

Taiwan (Headquarters)

Quanta Cloud Technology

1F, No. 211 Wenhua 2nd Rd., Guishan Dist., Taoyuan City
33377, Taiwan
TEL: +886-3-286-0707
FAX: +886-3-327-0001

United States

Quanta Cloud Technology USA LLC., Silicon Valley Office

1010 Rincon Circle, San Jose, CA 95131
TOLL-FREE: 1-855-QCT-MUST
TEL: +1-510-270-6111
FAX: +1-510-270-6161
Support: +1-510-270-6216

Quanta Cloud Technology USA LLC., Seattle Office

13810 SE Eastgate Way, Suite 190, Building 1,
Bellevue, WA 98005
TEL: +1-425-633-1620
FAX: +1-425-633-1621

Japan

Quanta Cloud Technology Japan Inc.

Shibadaimon-Makita Building 3F, 2-5-8, Shibadaimon,
Minato-ku, Tokyo 105-0012, Japan
TEL: +81-3-5777-0818
FAX: +81-3-5777-0819

Quanta Cloud Technology Japan K.K.

7-8-6, Roppongi, Minato-ku, Tokyo 106-0032, Japan

Germany

Quanta Cloud Technology Germany GmbH

Rurbenden 48, 52353 Düren
TEL: +49-2421-3863400
FAX: +49-2421-3863899

Korea

QCT Korea, Inc.

10F, Kyobo Securities Building, 97 Uisadang-daero, Yeong-
deungpo-gu, Seoul, 07327, KOREA
TEL: +82-10-2057-5650
FAX: +82-2-6336-6710

Singapore

Quanta Cloud Technology Singapore Pte. Ltd.

1 Changi Business Park Central 1 #02-113 One@Changi City
Singapore 486036
TEL: +65-6908-0958

intel Powered by
Intel® Technology.

Intel, the Intel logo, Xeon, and Xeon Inside are trademarks or registered trademarks of Intel Corporation in the U.S. and/or other countries.